

## ML6206 Series Low ESR Cap. Compatible Positive Voltage Regulator

### ❖ *Application*

- ◆ *Battery Powered Equipment*
- ◆ *Palmtops*
- ◆ *Portable Cameras and Video Recorders*
- ◆ *Reference Voltage Sources*

### ❖ *Features*

- CMOS Low Power Consumption :  
Typical 1.0uA at  $V_{out}=3.0V$
- Output Voltage Range : 1.5V to 5.0V in 0.1V increments
- Highly Accurate:  
Output Voltage  $\pm 3\%$  for 1.5V to 1.9V  
Output Voltage  $\pm 2\%$  for 2.0V to 5.0V
- Maximum Output Current: 250mA  
(within the maximum power dissipation,  $V_{out}=5.0V$ )
- Small Input-Output Voltage Differential:  
0.16V at 100mA and 0.4V at 200mA
- Input stability: Typ. 0.2%/V
- Package Available:  
SOT-23 (150mW), SOT-89 (500mW) &  
TO-92 (300mW)
- Reverse Battery Protection
- Current Limit

### ❖ *General Description*

The ML6206 series are highly precise, low power consumption, high voltage, positive voltage output, three-pin regulator. It provides high output current even when the input/output voltage differential is small.

The ML6206 consists of a high-precision voltage reference, an error correction circuit, a current limited output driver and reverse battery protection.

### ❖ *Block Diagram*

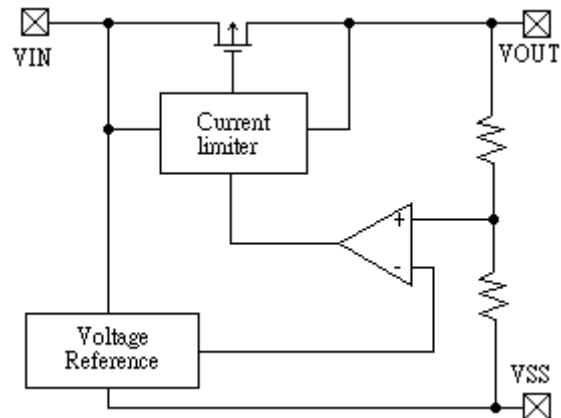

### *Absolute Maximum Ratings*

Parameter		Symbol	Ratings	Units
Input Voltage		$V_{IN}$	6.5	V
Output Current		$I_{OUT}$	500	mA
Output Voltage		$V_{OUT}$	$V_{SS}-0.3 \sim V_{IN}+0.3$	V
Continuous Total Power Dissipation	SOT-23	$P_d$	150	mW
	SOT-89		500	
	TO-92		300	
Operating Ambient Temperature		$T_{opr}$	-40 ~ +70	$^{\circ}C$
Storage Temperature		$T_{stg}$	-40 ~ +70	$^{\circ}C$

❖ *Pin Configuration*

**SOT-23**

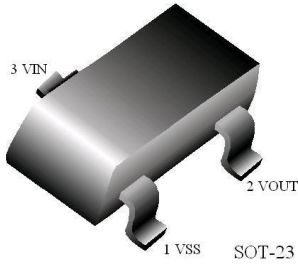

**SOT-89**

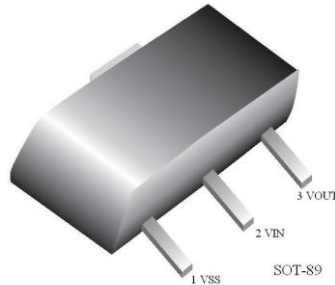

**TO-92**

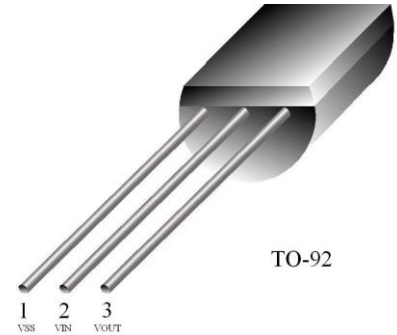

Package Pin Number			Pin Name	Function
SOT23	SOT89	TO-92		
1	1	1	VSS	Ground
3	2	2	VIN	Power Input
2	3	3	VOUT	Output

❖ *Standard Circuit*

**Note on Use**

- Oscillation may occur as a result of the impedance present between the power supply and the IC's input. Please use a capacitor (CIN) of at least 1uF, when the impedance is 10 ohm or more.  
With a large output current, Voltage output can be stabilised by increasing capacitor (CIN) size. If CIN is small and capacitor (CL) size is increased, oscillation may occur. In such cases, Voltage output can be stabilised by either increasing the size of CIN or decreasing the size of CL.
- Please ensure that output current (IOUT) is less than  $P_d / (V_{IN} - V_{OUT})$  and does not exceed the stipulated Continuous Total Power Dissipation value (Pd).

❖ *Test Circuit*

Test Circuit 1

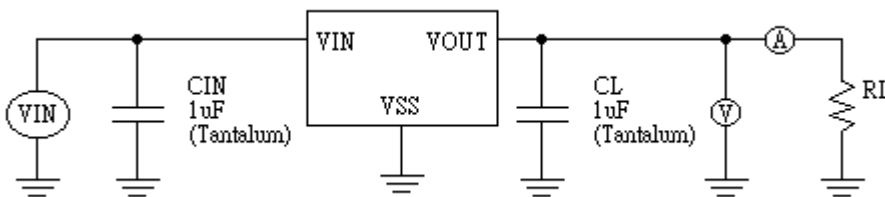

Test Circuit 2

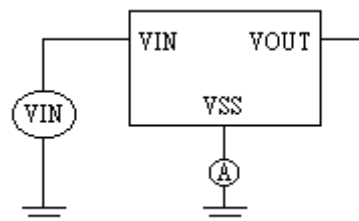

## ❖ Electrical Characteristic

### ML6206P153 $V_{OUT}(T)=1.5V$ (Note 1)

Parameter	Symbol	Conditions	Min	Typ	Max	Units	Circuit
Output Voltage	$V_{OUT}(E)$ (Note 2)	$I_{OUT}=30mA$ $V_{IN}=2.5V$	1.455	1.500	1.545	V	1
Maximum Output Current	$I_{OUT\ max}$	$V_{IN}=2.5V, V_{OUT}(E) \geq 1.35V$	200			mA	1
Load Stability	$\Delta V_{OUT}$	$V_{IN}=2.5V, 1mA \leq I_{OUT} \leq 100mA$		35		mV	1
Input –Output Voltage Differential (Note 3)	$V_{dif1}$	$I_{OUT}=100mA$		250		mV	1
	$V_{dif2}$	$I_{OUT}=200mA$		500		mV	1
Supply Current	$I_{SS}$	$V_{IN}=2.5V$		1.0		$\mu A$	2
Input Stability	$\frac{\Delta V_{OUT}}{\Delta V_{IN} * V_{OUT}}$	$I_{OUT}=30mA$ $V_{OUT}(T)+1.0V \leq V_{IN} \leq 6V$		0.01	0.30	%V	1
Input Voltage	$V_{IN}$		1.2		6.5	V	-
Current Limiter	$I_{short}$	$V_{IN} = V_{OUT}+1.5V, V_{OUT}=V_{SS}$		100		mA	1

### ML6206P183 $V_{OUT}(T)=1.8V$ (Note 1)

Parameter	Symbol	Conditions	Min	Typ	Max	Units	Circuit
Output Voltage	$V_{OUT}(E)$ (Note 2)	$I_{OUT}=30mA$ $V_{IN}=2.8V$	1.746	1.800	1.854	V	1
Maximum Output Current	$I_{OUT\ max}$	$V_{IN}=2.8V, V_{OUT}(E) \geq 1.62V$	200			mA	1
Load Stability	$\Delta V_{OUT}$	$V_{IN}=2.8V, 1mA \leq I_{OUT} \leq 100mA$		35		mV	1
Input –Output Voltage Differential (Note 3)	$V_{dif1}$	$I_{OUT}=100mA$		250		mV	1
	$V_{dif2}$	$I_{OUT}=200mA$		500		mV	1
Supply Current	$I_{SS}$	$V_{IN}=2.8V$		1.0		$\mu A$	2
Input Stability	$\frac{\Delta V_{OUT}}{\Delta V_{IN} * V_{OUT}}$	$I_{OUT}=30mA$ $V_{OUT}(T)+1.0V \leq V_{IN} \leq 6V$		0.01	0.30	%V	1
Input Voltage	$V_{IN}$		1.2		6.5	V	-
Current Limiter	$I_{short}$	$V_{IN} = V_{OUT}+1.5V, V_{OUT}=V_{SS}$		100		mA	1

### ML6206P212 $V_{OUT}(T)=2.1V$ (Note 1)

Parameter	Symbol	Conditions	Min	Typ	Max	Units	Circuit
Output Voltage	$V_{OUT}(E)$ (Note 2)	$I_{OUT}=30mA$ $V_{IN}=3.1V$	2.058	2.100	2.142	V	1
Maximum Output Current	$I_{OUT\ max}$	$V_{IN}=3.1V, V_{OUT}(E) \geq 1.89V$	240			mA	1
Load Stability	$\Delta V_{OUT}$	$V_{IN}=3.1V, 1mA \leq I_{OUT} \leq 100mA$		30		mV	1
Input –Output Voltage Differential (Note 3)	$V_{dif1}$	$I_{OUT}=100mA$		180		mV	1
	$V_{dif2}$	$I_{OUT}=200mA$		390		mV	1
Supply Current	$I_{SS}$	$V_{IN}=3.1V$		1.0		$\mu A$	2
Input Stability	$\frac{\Delta V_{OUT}}{\Delta V_{IN} * V_{OUT}}$	$I_{OUT}=30mA$ $V_{OUT}(T)+1.0V \leq V_{IN} \leq 6V$		0.01	0.30	%V	1
Input Voltage	$V_{IN}$		1.2		6.5	V	-
Current Limiter	$I_{short}$	$V_{IN} = V_{OUT}+1.5V, V_{OUT}=V_{SS}$		100		mA	1

### ML6206P302 $V_{OUT}(T)=3.0V$ (Note 1)

Parameter	Symbol	Conditions	Min	Typ	Max	Units	Circuit
Output Voltage	$V_{OUT}(E)$ (Note 2)	$I_{OUT}=30mA$ $V_{IN}=4.0V$	2.940	3.000	3.060	V	1
Maximum Output Current	$I_{OUT\ max}$	$V_{IN}=4.0V, V_{OUT}(E) \geq 2.7V$	270			mA	1
Load Stability	$\Delta V_{OUT}$	$V_{IN}=4.0V, 1mA \leq I_{OUT} \leq 100mA$		25		mV	1
Input –Output Voltage Differential (Note 3)	$V_{dif1}$	$I_{OUT}=100mA$		120		mV	1
	$V_{dif2}$	$I_{OUT}=200mA$		260		mV	1
Supply Current	$I_{SS}$	$V_{IN}=4.0V$		1.0		$\mu A$	2
Input Stability	$\frac{\Delta V_{OUT}}{\Delta V_{IN} * V_{OUT}}$	$I_{OUT}=30mA$ $V_{OUT}(T)+1.0V \leq V_{IN} \leq 6V$		0.01	0.30	%V	1
Input Voltage	$V_{IN}$		1.2		6.5	V	-
Current Limiter	$I_{short}$	$V_{IN} = V_{OUT}+1.5V, V_{OUT}=V_{SS}$		100		mA	1

**ML6206P332  $V_{OUT}(T)=3.3V$ (Note 1)**

Parameter	Symbol	Conditions	Min	Typ	Max	Units	Circuit
Output Voltage	$V_{OUT}(E)$ (Note 2)	$I_{OUT}=30mA$ $V_{IN}=4.3V$	3.234	3.300	3.366	V	1
Maximum Output Current	$I_{OUT\ max}$	$V_{IN}=4.3V, V_{OUT}(E) \geq 2.97V$	270			mA	1
Load Stability	$\Delta V_{OUT}$	$V_{IN}=4.3V, 1mA \leq I_{OUT} \leq 100mA$		25		mV	1
Input –Output Voltage Differential (Note 3)	$V_{dif1}$	$I_{OUT}=100mA$		120		mV	1
	$V_{dif2}$	$I_{OUT}=200mA$		260		mV	1
Supply Current	$I_{SS}$	$V_{IN}=4.3V$		1.0		$\mu A$	2
Input Stability	$\frac{\Delta V_{OUT}}{\Delta V_{IN} * V_{OUT}}$	$I_{OUT}=30mA$ $V_{OUT}(T)+1.0V \leq V_{IN} \leq 6V$		0.01	0.30	%V	1
Input Voltage	$V_{IN}$		1.2		6.5	V	-
Current Limiter	$I_{short}$	$V_{IN} = V_{OUT}+1.5V, V_{OUT}=V_{SS}$		100		mA	1

**ML6206P502  $V_{OUT}(T)=5.0V$ (Note 1)**

Parameter	Symbol	Conditions	Min	Typ	Max	Units	Circuit
Output Voltage	$V_{OUT}(E)$ (Note 2)	$I_{OUT}=30mA$ $V_{IN}=6.0V$	4.900	5.000	5.100	V	1
Maximum Output Current	$I_{OUT\ max}$	$V_{IN}=6.0V, V_{OUT}(E) \geq 4.5V$	270			mA	1
Load Stability	$\Delta V_{OUT}$	$V_{IN}=6.0V, 1mA \leq I_{OUT} \leq 100mA$		25		mV	1
Input –Output Voltage Differential (Note 3)	$V_{dif1}$	$I_{OUT}=100mA$		110		mV	1
	$V_{dif2}$	$I_{OUT}=200mA$		260		mV	1
Supply Current	$I_{SS}$	$V_{IN}=5.0V$		1.0		$\mu A$	2
Input Stability	$\frac{\Delta V_{OUT}}{\Delta V_{IN} * V_{OUT}}$	$I_{OUT}=30mA$ $5.0V \leq V_{IN} \leq 6.5V$		0.01	0.30	%V	1
Input Voltage	$V_{IN}$		1.2		6.5	V	-
Current Limiter	$I_{short}$	$V_{IN} = V_{OUT}+1.5V, V_{OUT}=V_{SS}$		100		mA	1

Note : 1.  $V_{OUT}(T)$  = Specified Output Voltage.

2.  $V_{OUT}(E)$  = Effective Output Voltage (i.e. the output voltage when  $(V_{OUT}(T)+1.0V)$  is provided at the  $V_{IN}$  pin while maintaining a certain  $I_{OUT}$  value).

3.  $V_{dif}$  =  $V_{IN1}$ (Note 4) –  $V_{OUT}(E)$

4.  $V_{IN1}$  = The input voltage at the time 98% of  $V_{OUT}(E)$  is output (input voltage has been gradually reduced).

❖ *Typical Performance Characteristics*

1) Output Voltage vs. Output Current

**ML6206P153**

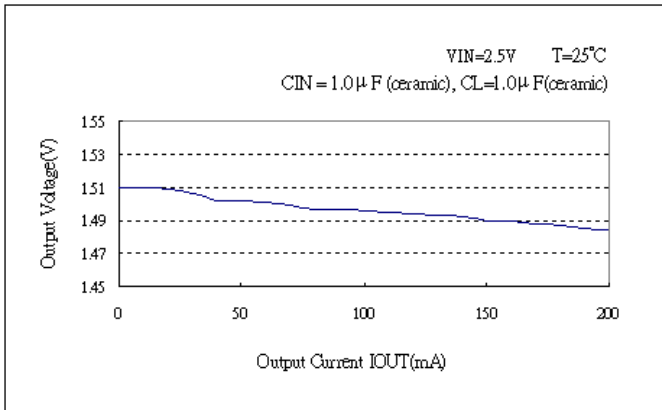

**ML6206P302**

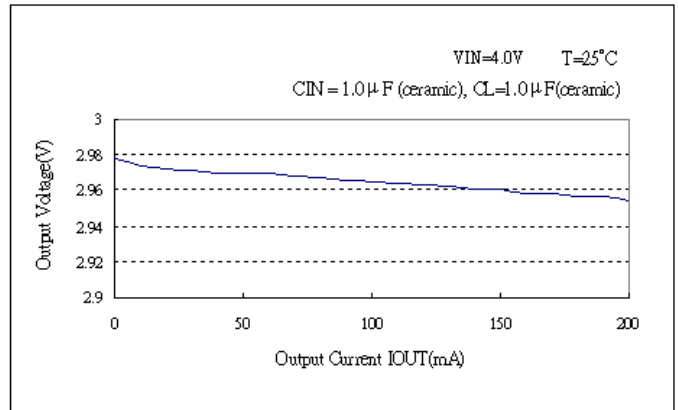

**ML6206P332**

Vin = 4.3V T= 25 C  
Cin = 1.0uF, CL= 1.0uF

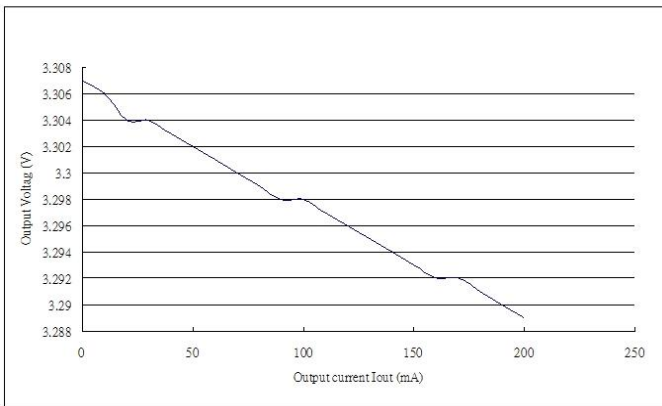

2) Current Limit

**ML6206P153**

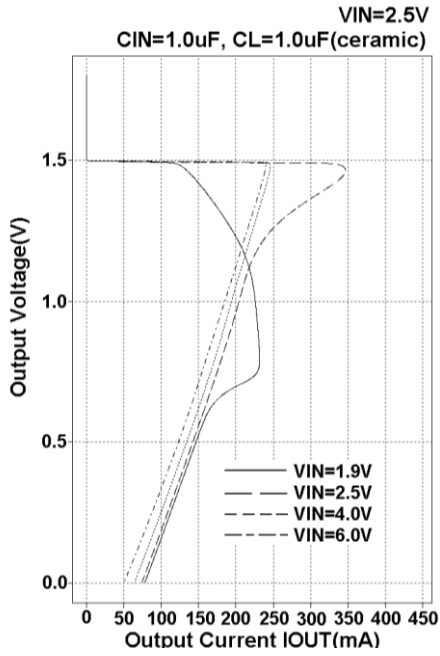

**ML6206P302**

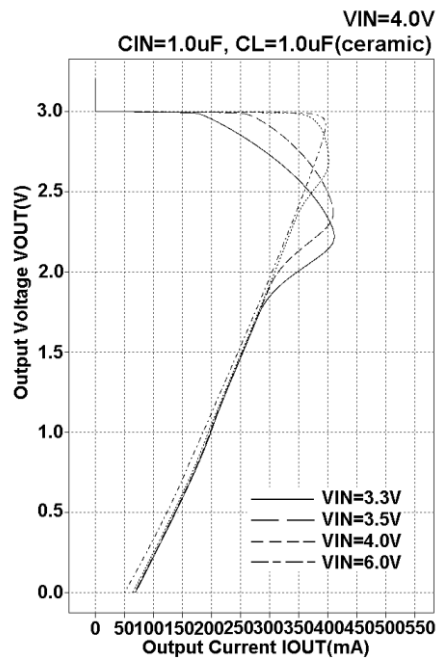

**ML6206P502**

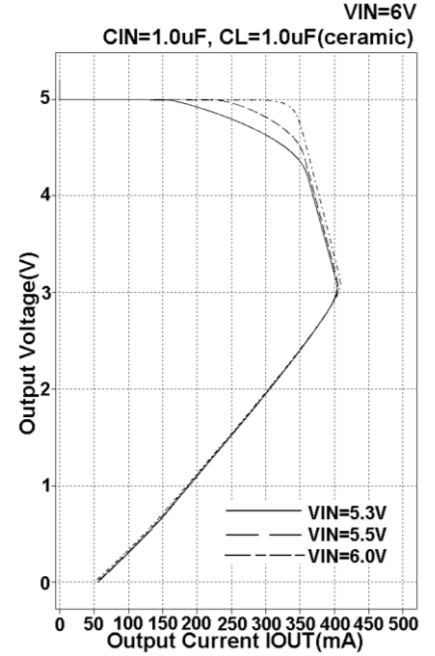

**ML6206P332**

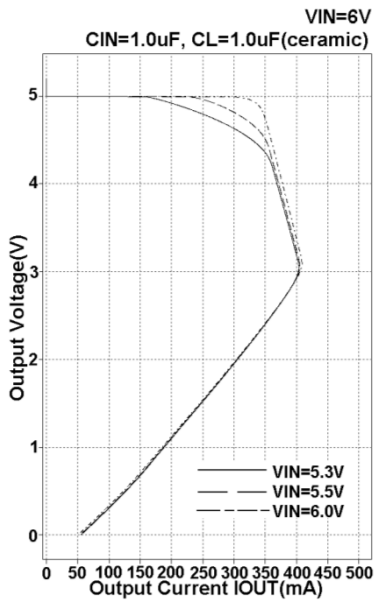

**3) Output Voltage vs. Input Voltage**

**ML6206P153**

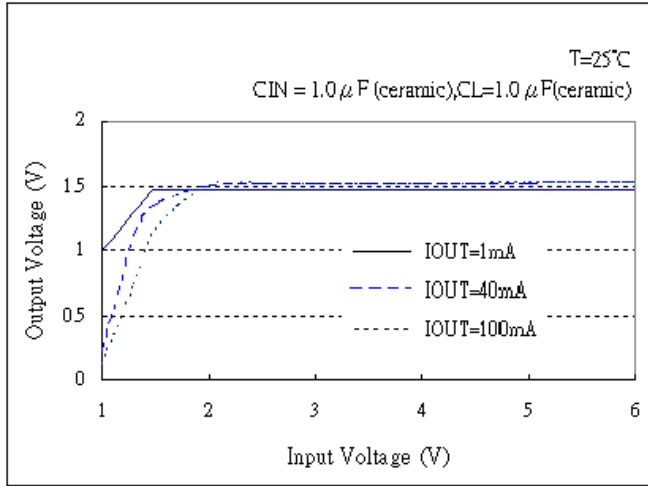

**ML6206P302**

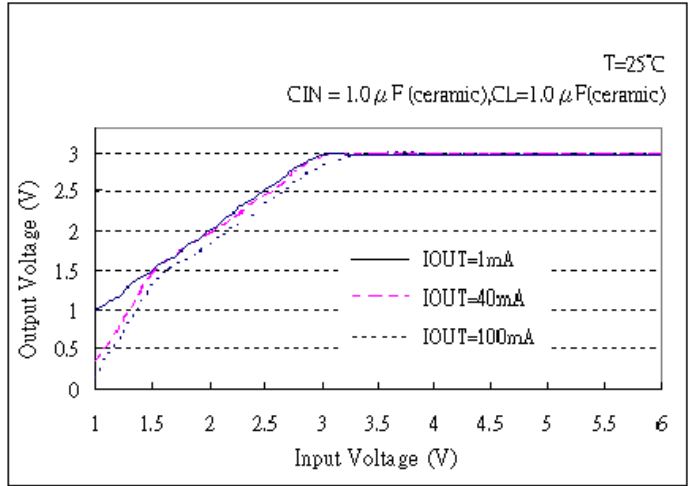

**ML6206P332**

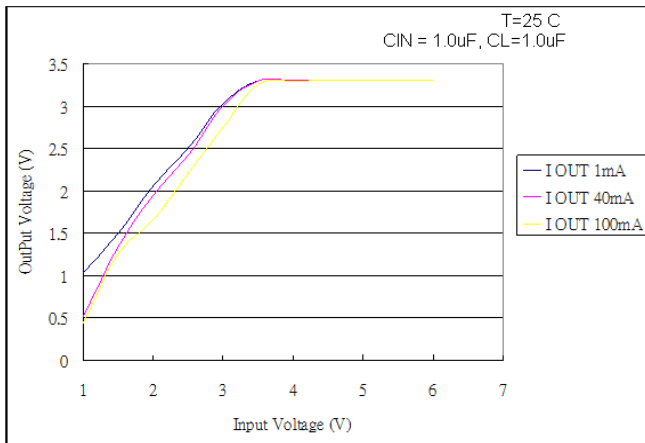

**4) Supply Current vs. Input Voltage**

**ML6206P153**

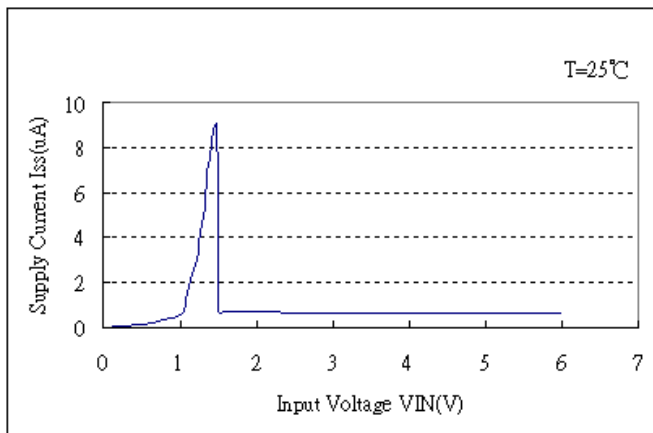

**ML6206P302**

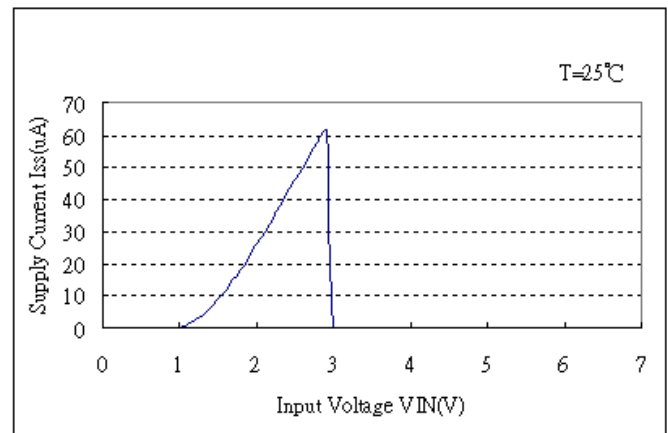

**ML6206P332**

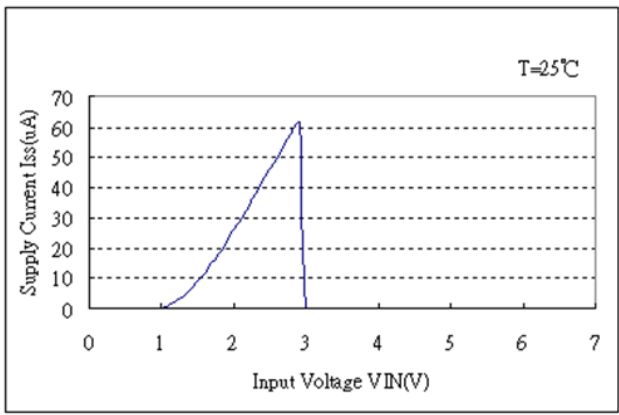

**5) Output Voltage vs. Ambient Temperature**

**ML6206P153**

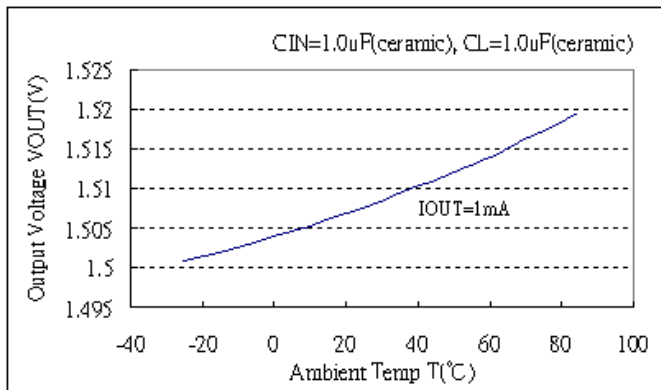

**ML6206P302**

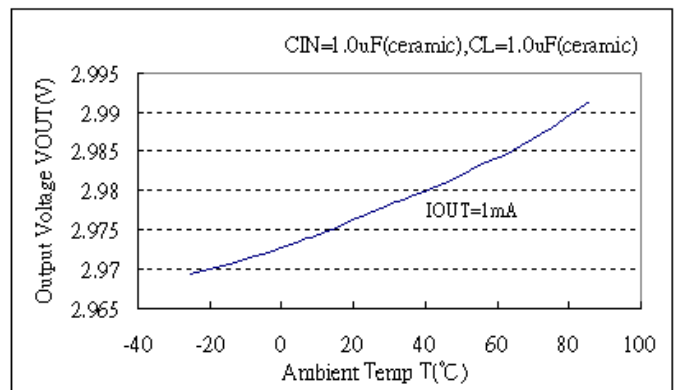

**ML6206P332**

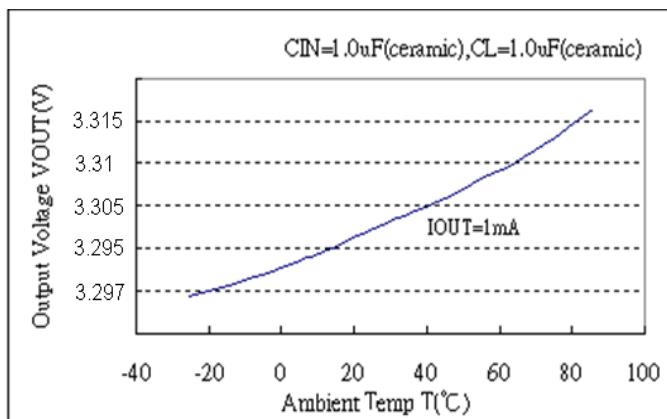



**6) Supply Current vs. Ambient Temperature**

**ML6206P153**

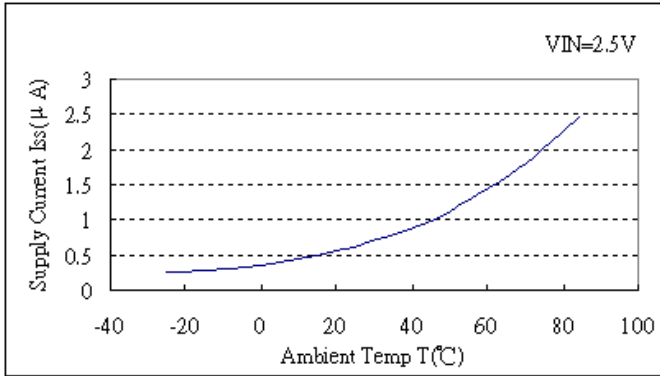

**ML6206P302**

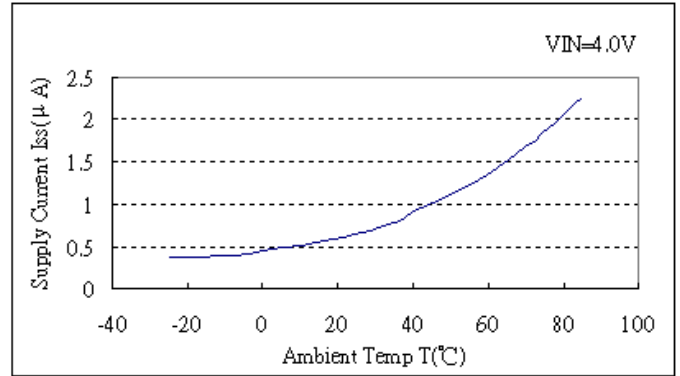

**ML6206P332**

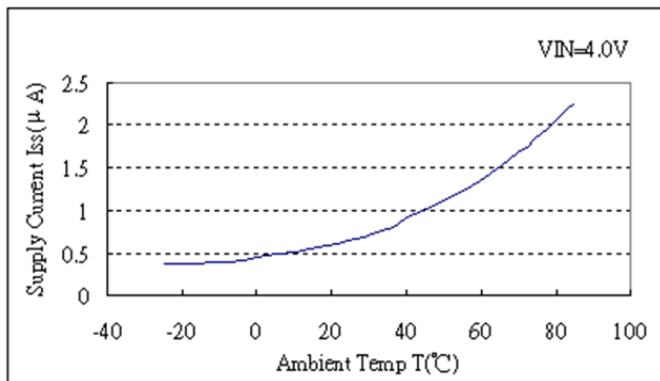

**7) Input Transient Response 1**

**ML6206P153**

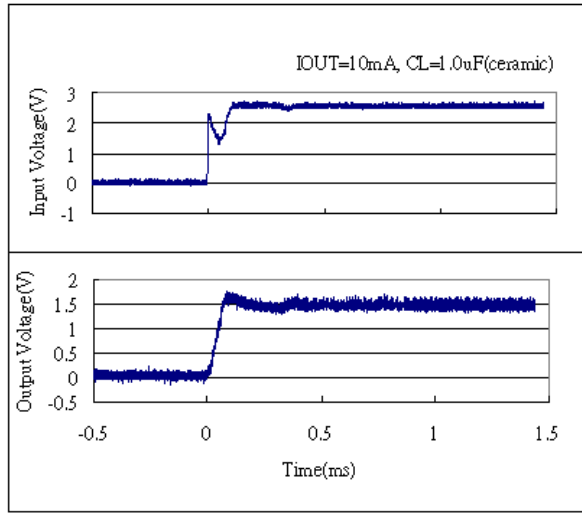
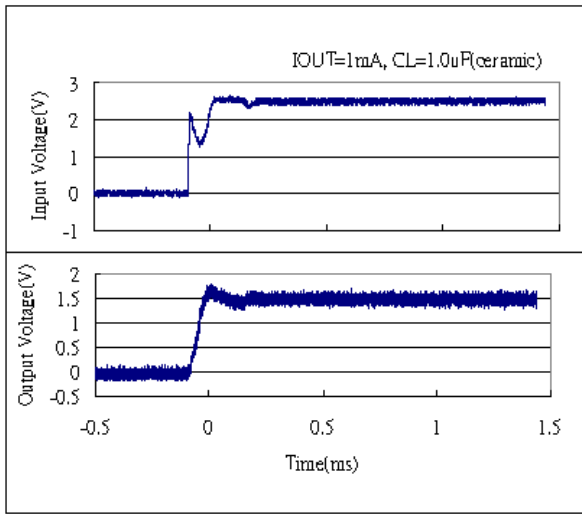

**ML6206P302**

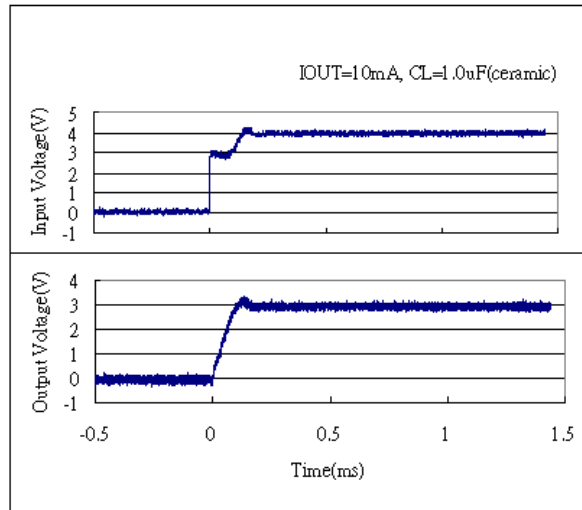
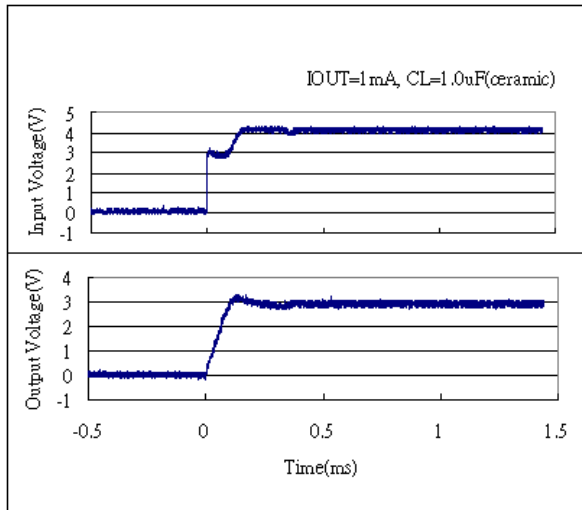

**ML6206P332**

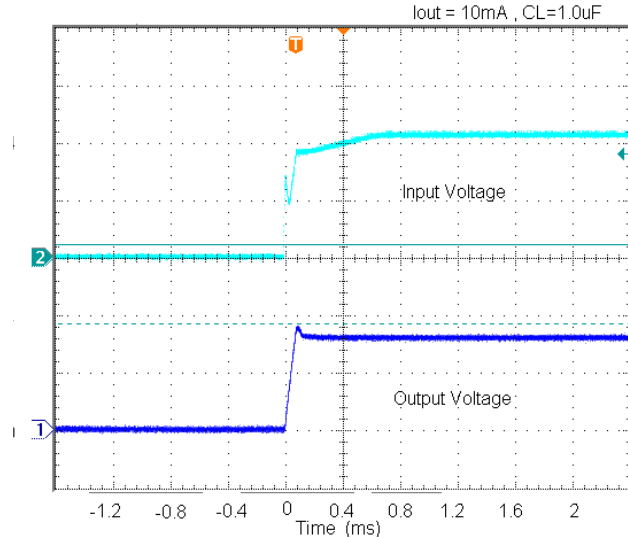
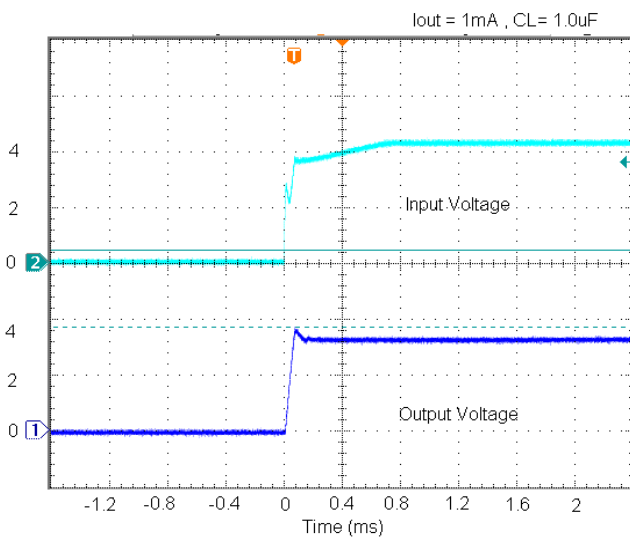

8) Input Transient Response 2

ML6206P153

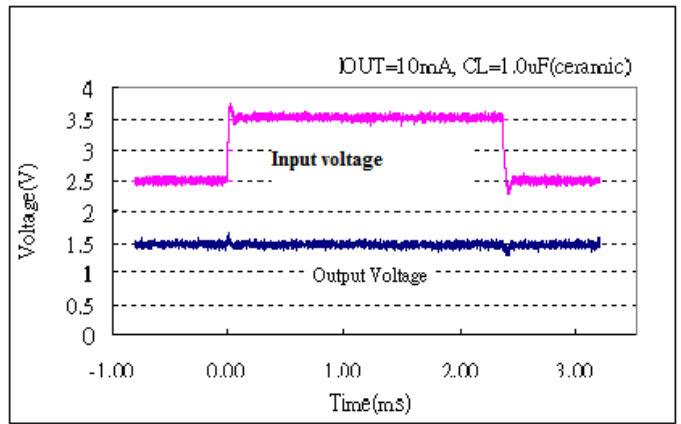
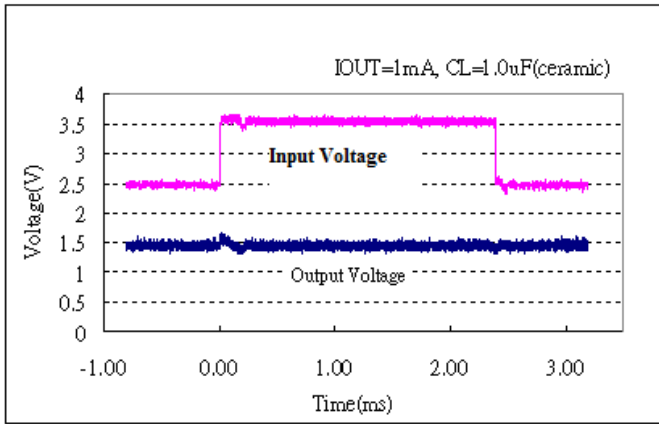

ML6206P302

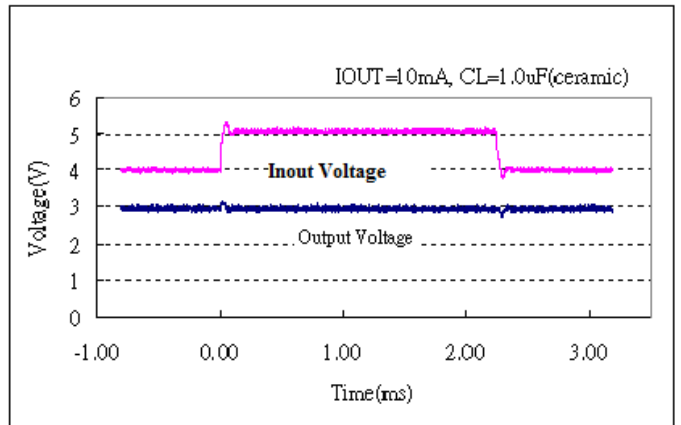
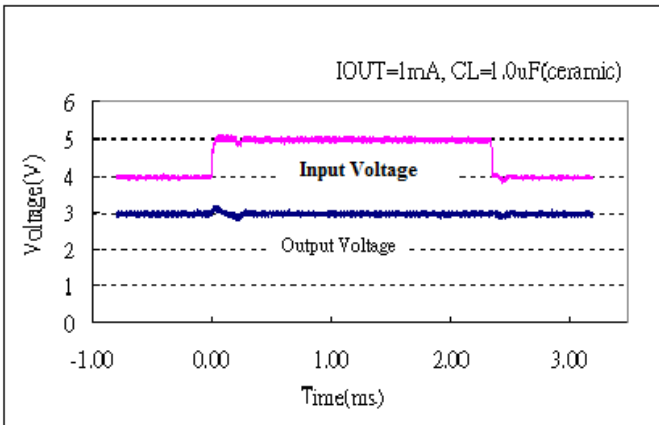

ML6206332

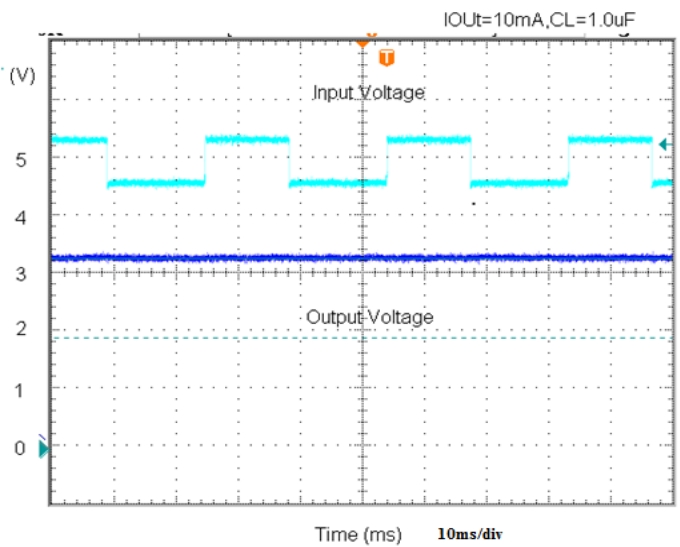
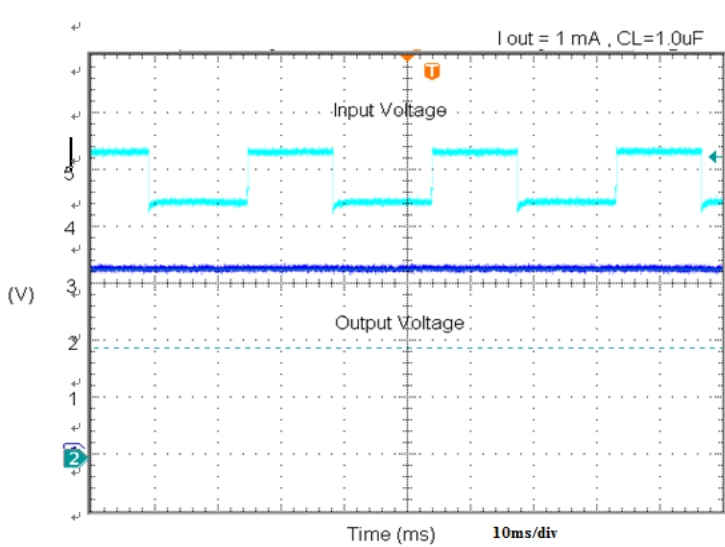

9) Load Transient Response

**ML6206P15**

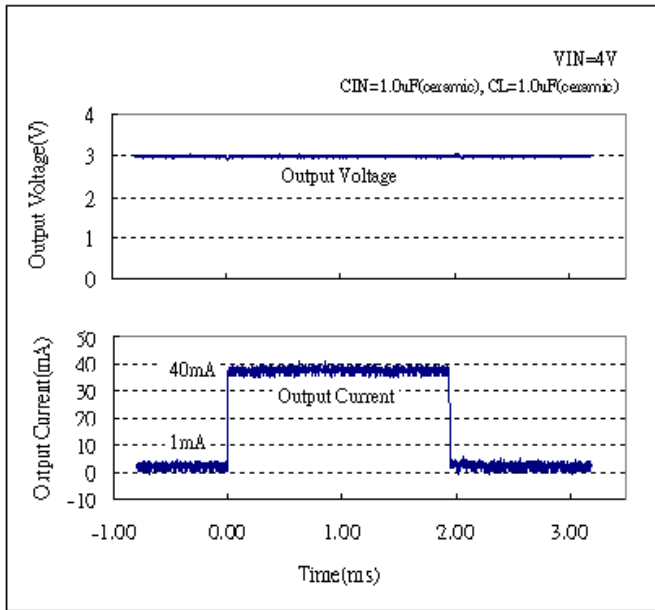

**ML6206P302**

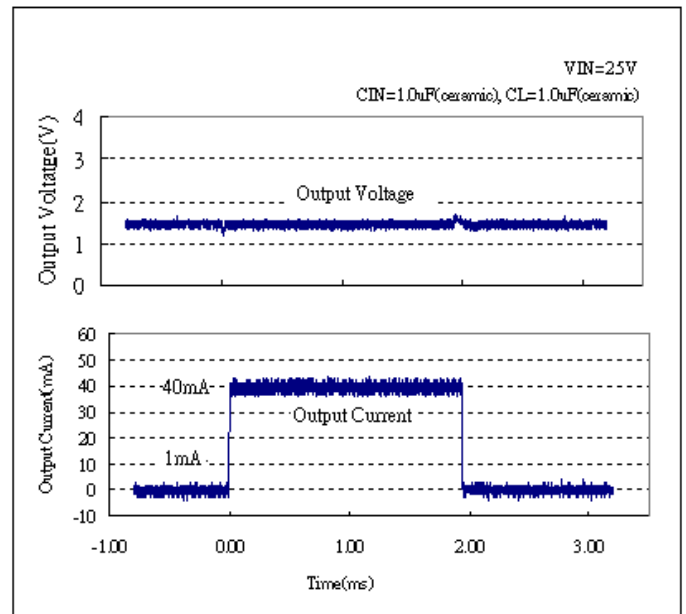

**ML6206P332**

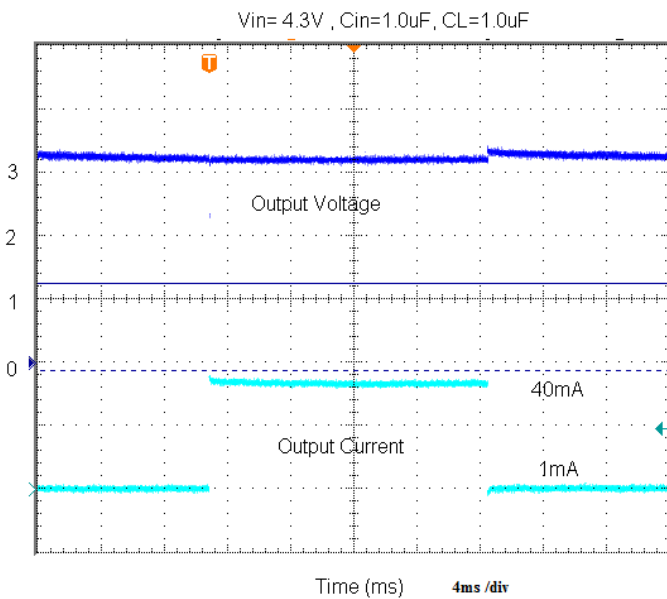

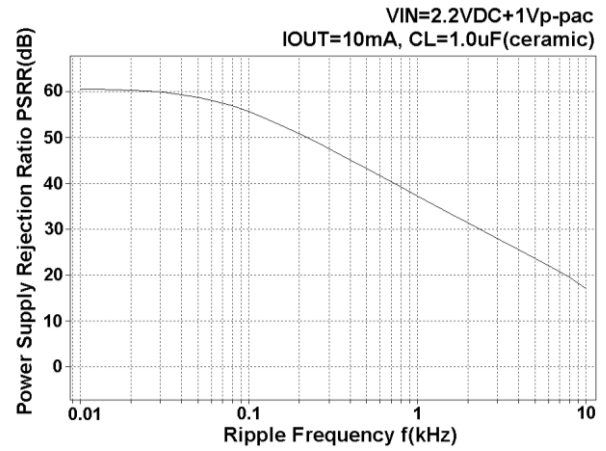
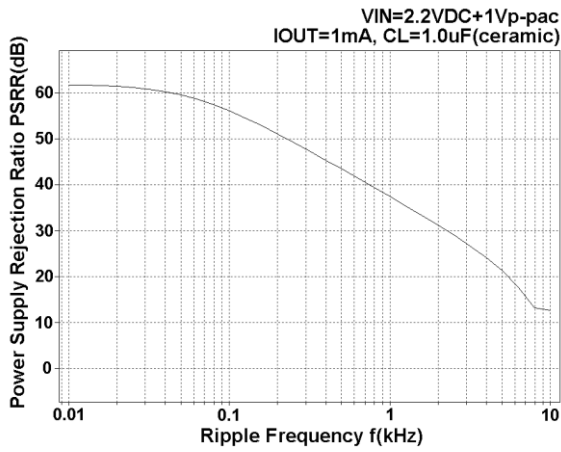
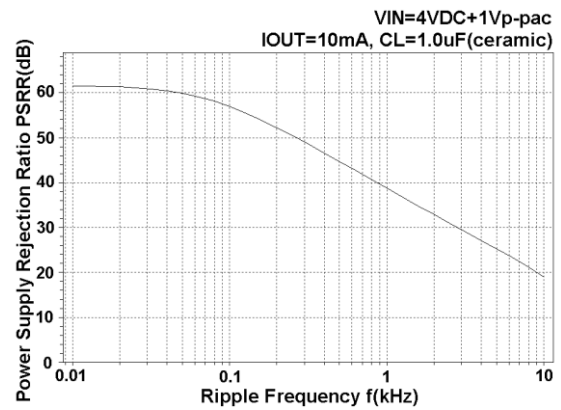
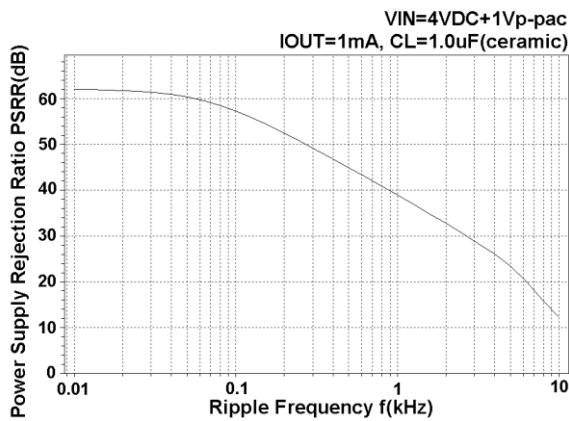
**10) Power Supply Rejection Ratio**
**ML6206P153**

**ML6206P332**

**❖ Ordering Information**

Designator	Description
①②	<b>Output Voltage</b> eg. 30=3.0V 50=5.0V
③	<b>Output Voltage Accuracy</b> 2 = ± 2.0% 3 = ± 3.0%
④	<b>Package Type</b> M = SOT-23 P = SOT-89 T = TO-92
⑤	<b>Device Orientation</b> R = Embossed Tape (Orientation of Device : Right) L = Embossed Tape (Orientation of Device : Left) B = Bag (TO-92) H = Paper Tape (TO-92)
⑥	G = ROHS Part

**ML6206P①②③④⑤⑥**

### ❖ *Marking*

#### SOT-23 :

Designator	Description
1	<b>Type</b> Z = Positive Voltage Regulator
2,3	<b>Output Voltage</b> eg. 30 = 3.0V
4	<b>Internal Code</b>

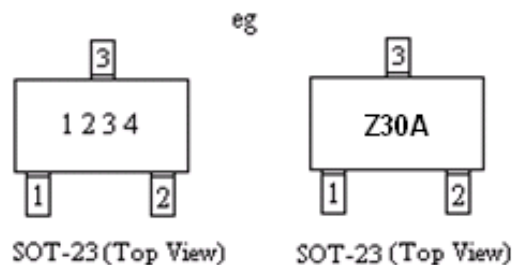

#### SOT-89 :

Designator	Description
1	<b>Type</b> Z = Positive Voltage Regulator
2,3	<b>Output Voltage</b> eg. 30 = 3.0V
4	<b>Output Voltage Accuracy</b> 2 = $\pm 2.0\%$ 3 = $\pm 3.0\%$
5	<b>Internal Code</b>

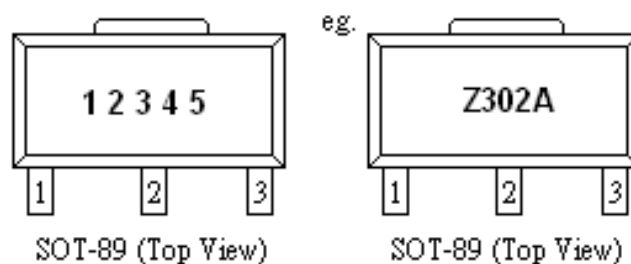

#### TO-92 :

Designator	Description
1	<b>Type</b> Z = Positive Voltage Regulator
2,3	<b>Output Voltage</b> eg. 30 = 3.0V
4	<b>Output Voltage Accuracy</b> 2 = $\pm 2.0\%$ 3 = $\pm 3.0\%$
5	<b>Internal code</b>
6, 7	<b>Year Code</b> eg. 09 = Year 2009
8, 9	<b>Week Code</b> eg. 10 = Week 10

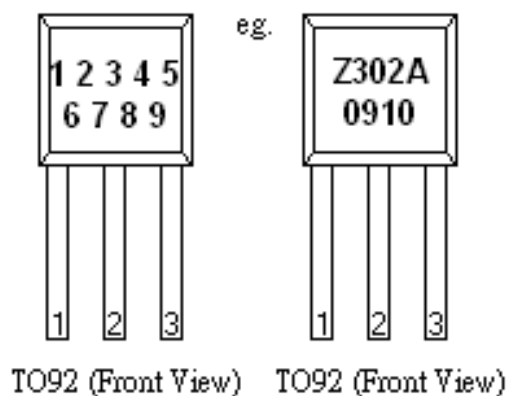

❖ *Packaging Information*

**SOT-23 :**

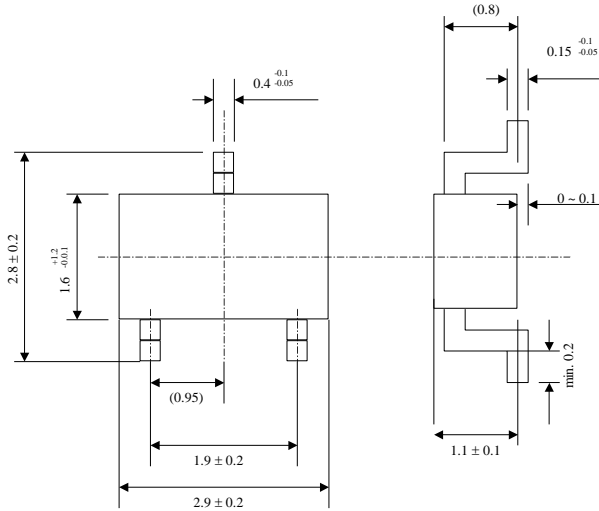

**SOT-89 :**

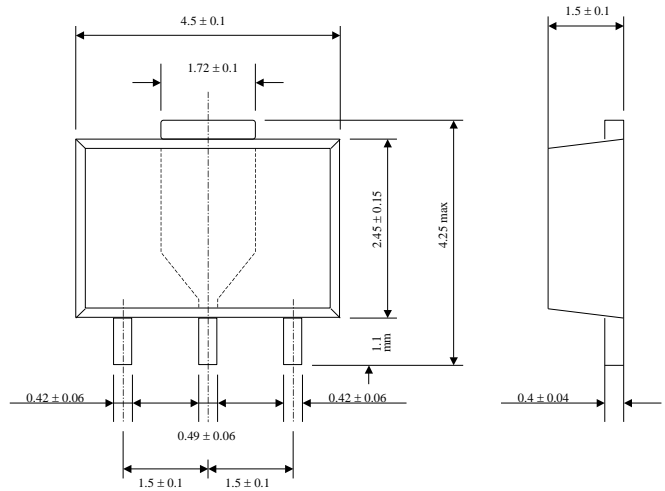

**TO-92 :**

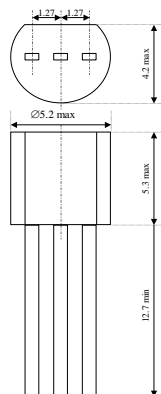

Units : mm

❖ *Recommended Pattern Layout*

**SOT-23 :**

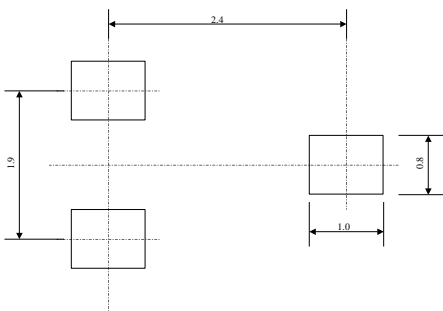

**SOT-89**

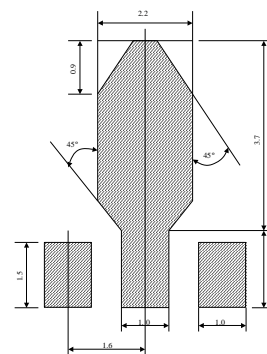

❖ *Tape and Reel Information*

SOT-23 :

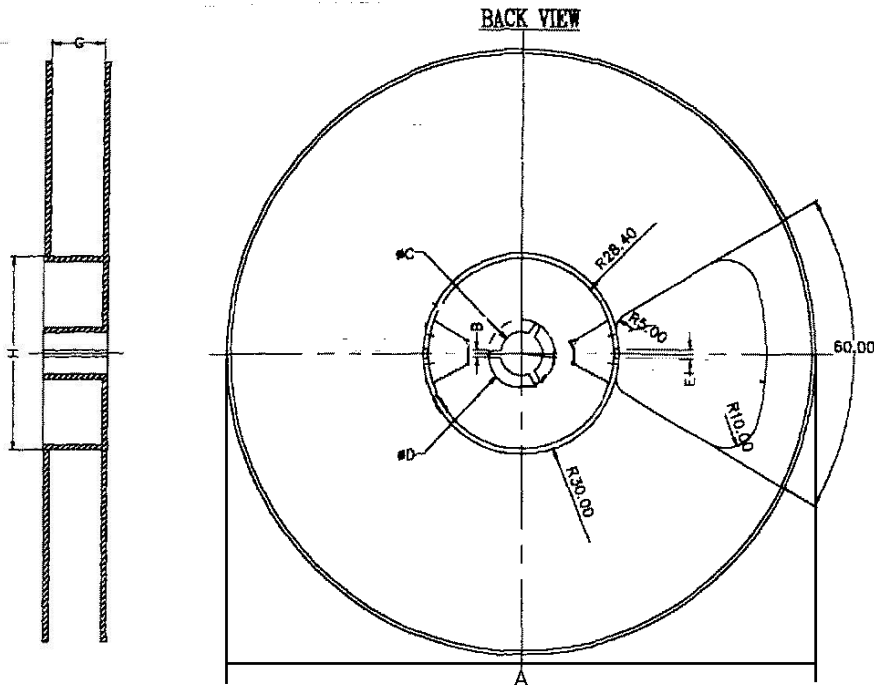

	SIZE (mm)
A	∅ 178 ± 0.8
B	2 ± 0.2
C	∅ 13 ± 0.2
D	∅ 21 ± 0.8
G	8 ± 0.5
H	∅ 60

3,000 pcs / reel

**SOT-23 Taping Specifications :**

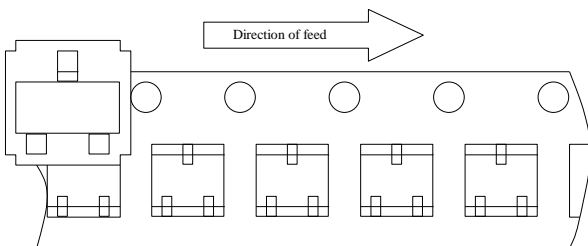
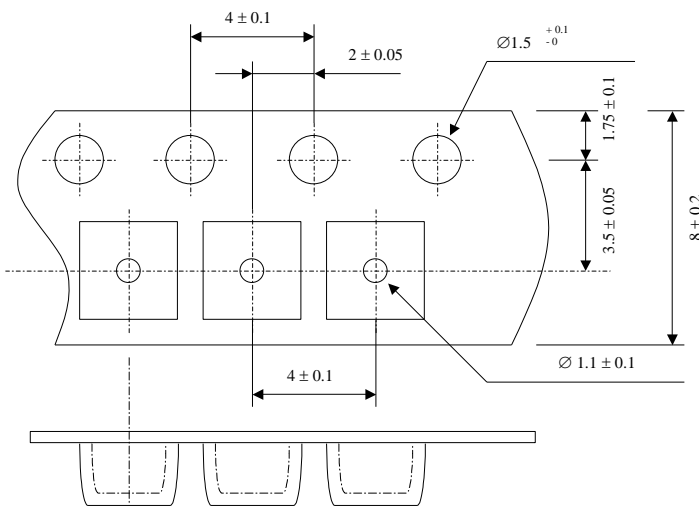

"R" type [Orientation of Device: Right]  
Standard Type

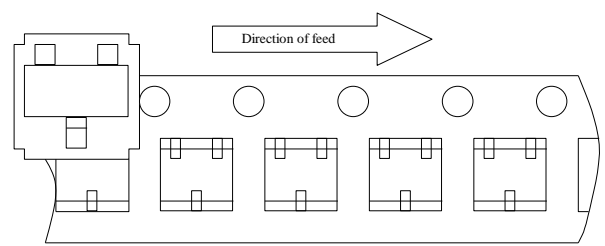

"L" type [Orientation of Device: Left]  
Reverse Type



**SOT-89 :**

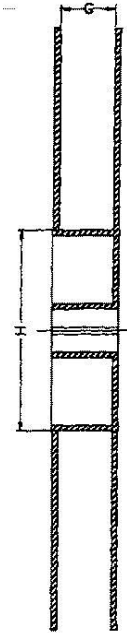
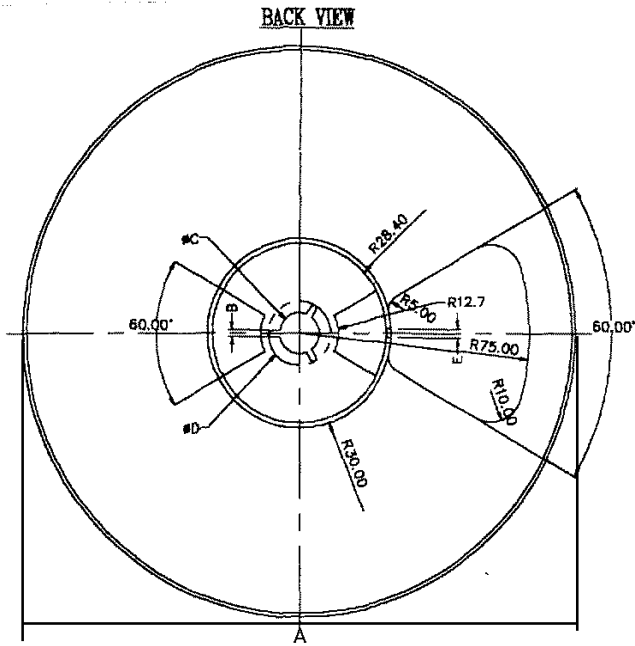

	SIZE (mm)
A	$\varnothing 178 \pm 0.8$
B	$2 \pm 0.2$
C	$\varnothing 13 \pm 0.2$
D	$\varnothing 21 \pm 0.8$
G	$12 \pm 0.5$
H	$\varnothing 60$

**SOT-89 Taping Specifications :**

1,000 pcs / reel

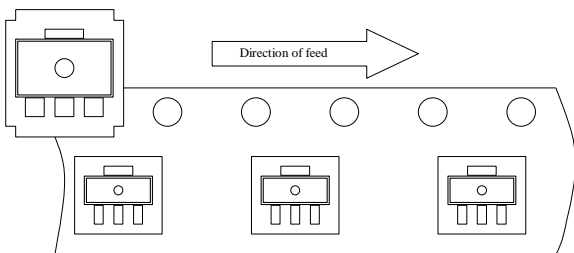
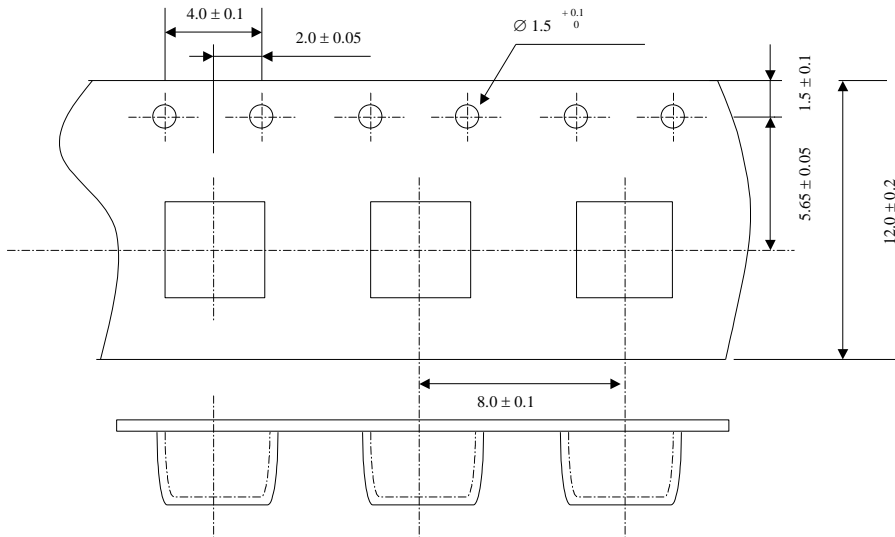

“R” type [Orientation of Device: Right]  
Standard Type

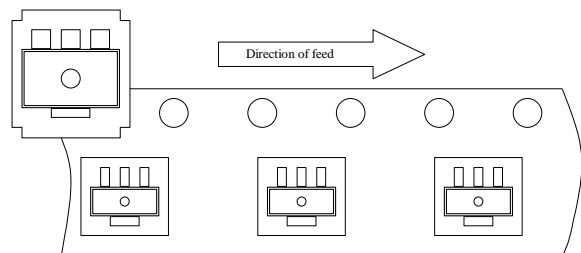

“L” type [Orientation of Device: Left]  
Reverse Type

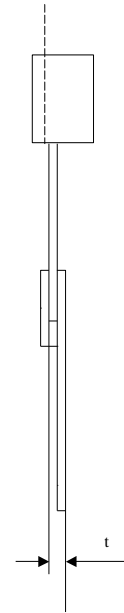
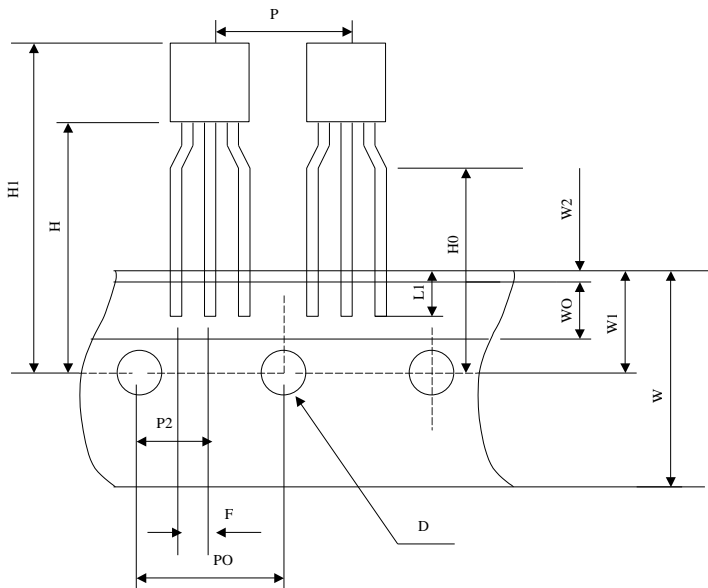
**TO-92 Taping Specifications :**

	SIZE (mm)
P	12.7 ± 1.0
PO	12.7 ± 0.3
P2	6.35 ± 0.4
F	2.5 <sup>+0.45</sup> <sub>-0.15</sub>
W	18.0 ± 1.0
W0	6.0 ± 0.3
W1	9.0 ± 0.5
W2	0.5 MAX
H	19.0 ± 0.5
H0	16.0 ± 0.5
H1	32.25 MAX
D	∅ 4.0 ± 0.2
t	0.6 ± 0.2
L1	3.5 MIN

2,000 pcs / box

MiniLogic reserves the rights to change the information and specifications without prior notice. The information presented in this document does not form part of any quotation or contract, is believed to be accurate and reliable and may be changed without notice. No liability will be accepted by the publisher for any consequence of its use.